

RIA Physics White Paper

The Nature of Nucleonic Matter

The Origin of the Elements

Tests of the Standard Model

ORDER OF CONTENTS

Preface

Introduction

The Nature of Nucleonic Matter

The Origin of the Elements and Energy Generation in Stars

Tests of the Standard Model and of Fundamental
Conservation Laws

Appendix

PREFACE

The physics associated with rare isotope beams is one of the major thrusts of nuclear science. It addresses basic questions of nuclear structure, nuclear astrophysics, and fundamental interaction physics.

Exotic beam facilities fall into two generic, and complementary, types – the fast beam or in-flight method and the ISOL or re-accelerated beam approach. The current upgrade of the NSCL at MSU positions the US as a leader in the exploitation of the in-flight method. The need for a next generation ISOL facility was discussed in early documents such as the 1991 U.S. IsoSpin Laboratory (ISL) White Paper and comparable Reports produced in Europe and Japan. These efforts culminated in the recommendation of an advanced exotic beam facility as the next major construction project following the completion of RHIC in the 1996 DOE/NSF Long Range Plan. This was reiterated in the 1999 National Academy (Schiffer) Report. Recently, an NSAC-commissioned (Grunder) Task Force defined what is now known as the Rare Isotope Accelerator (RIA) concept as the optimal realization of a next generation exotic beam facility.

RIA is an innovative, state-of-the-art-defining concept embodying the best features of both in-flight and ISOL techniques and providing both reaccelerated and fast beams. Owing to its greatly expanded capabilities relative to previous concepts, RIA will be the most powerful facility of its kind in the world. In view of these enhancements, it was decided to hold a Workshop, prior to the

current Long Range Plan process, devoted to sharpening the scientific case for RIA and discussing the merits and urgency of this project.

Accordingly, from July 24-26, 2000, approximately 215 nuclear physicists met in Raleigh-Durham, North Carolina, for a Workshop devoted to the physics opportunities offered by RIA. The discussions comprised four areas of RIA science – Nuclear Structure, Nuclear Reactions, Astrophysics and Fundamental Interaction Physics. The goal was to produce a concise White Paper outlining this science.

The present document is the result of that effort. It provides a level of detail intermediate between previous White Papers and the short executive summaries that usually accompany such reports. With such a format, we hope to provide an overview of RIA science that will be useful to a wide audience of nuclear physicists. Though the discussion is thematic, it is based on a large number of specific experiments whose parameters and feasibility were vetted during the conference by a “Reality check group” of technical experts on RIA capabilities and advanced nuclear instrumentation, using a realistic set of pre-established exotic beam intensities.

The following discussion is not a complete description of the scientific opportunities at RIA. Further, more detailed, information can be found in several documents on physics opportunities with exotic beams, in particular, the 1996 Long Range Plan report, the White Paper “Scientific

Opportunities with an Advanced ISOL Facility” prepared following the 1997 Columbus, Ohio Workshop, the recent NSCL White Paper “Scientific Oppor-

tunities with Fast Fragmentation Beams from the Rare Isotope Accelerator”, and the 1999 National Academy Report.

INTRODUCTION

The atomic nucleus, lying at the core of every atom and comprising over 99.9% of its mass, is a unique many-body quantal system in which nucleons interact via the strong, electromagnetic, and weak interactions. Besides the obvious and central aspect of the nucleus itself, the scope of nuclear physics has broadened in the last decade to include new areas focusing on the interactions of quarks and gluons and on the sub-structure of the nucleon. These main areas of study of strongly interacting matter are intimately related but nevertheless may be schematically illustrated as in Fig. 1. Studies at relativistic energies, as at RHIC, probe the nature of quark-gluon confinement and the assumptions underlying QCD. Work at CEBAF at the Jefferson Laboratory probes the quark-gluon structure of hadrons and of nuclei. Studies at lower energies, with beams of both stable and unstable nuclei, probe the structure and dynamics of nuclei. Here, RIA would lead the way, with unsurpassed capabilities and discovery potential, by providing access to the wider, uncharted landscape of unstable nuclei shown in Fig. 2. Together, these three focus areas of nuclear physics allow us to investigate and understand one of the most fundamental entities in the Universe.

Research with RIA will provide significant insights into an important problem that, in fact, appears in many different fields of modern science: how the properties of complex systems follow from the number, properties, and interactions of their constituents. Studies in materials science include an effort to derive the properties of macroscopic objects from those of their

molecular or atomic constituents. Likewise, biology strives to understand the properties of complex organisms based on the properties of their constituent cells and molecules. Chemistry strives to derive the properties of complex molecules from those of their atoms. Nuclear science strives to explain the properties of hadrons from those of quarks and gluons, and the properties of nuclei from those of protons and neutrons. RHIC and CEBAF provide the modern experimental tools to address the first of these nuclear science problems; RIA will be their counterpart for the second. Indeed, like these other facilities, RIA is a paradigm for the way technological breakthroughs can re-direct a branch of science into new directions.

The field of nuclear physics with exotic nuclei is both rich and diverse. It is important to stress that there are many critical scientific questions that can be addressed with these beams. This immediately presents a problem for succinct exposition and, indeed, there is a danger of oversimplifying the vast scientific enterprise at hand by reducing the discussion of these opportunities to short catchphrases. Nevertheless, it is useful to classify the scientific purview of exotic beam science according to the following three themes:

- **The Nature of Nucleonic Matter**
- **The Origin of the Elements and Energy Generation in Stars**
- **Tests of the Standard Model and of Fundamental Conservation Laws**

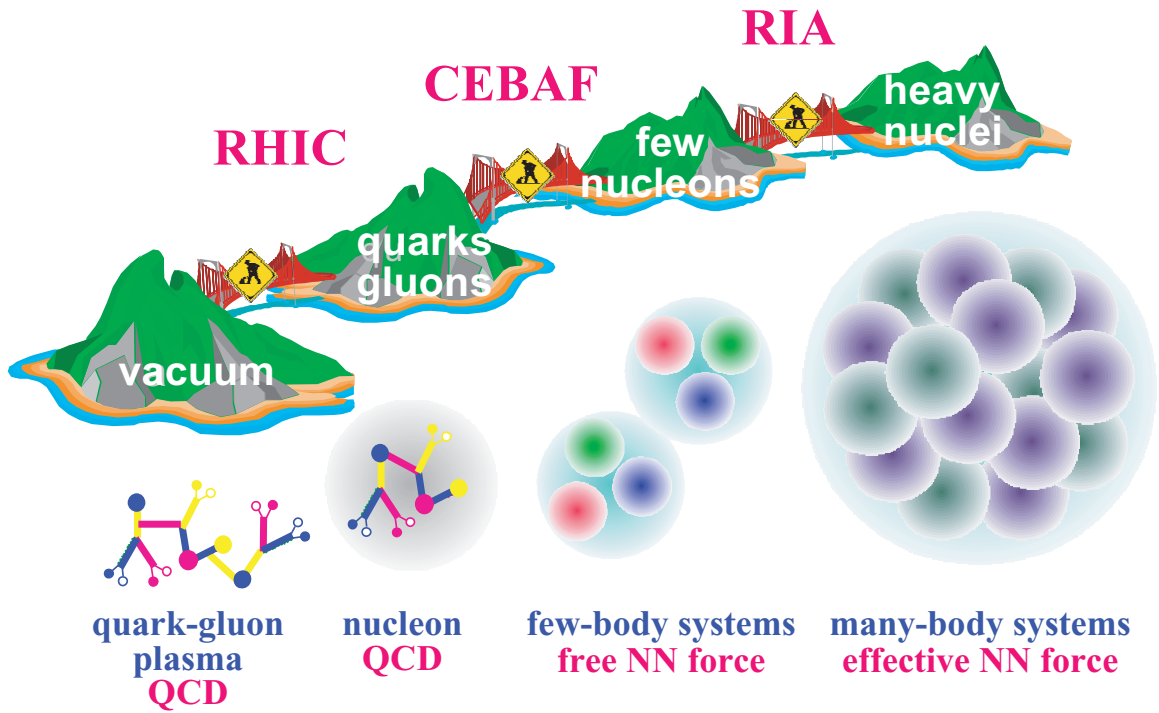

Figure 1: From QCD vacuum to heavy nuclei: the intellectual connection between the hadronic many-body problem (quark-gluon description of a nucleon) and the nucleonic many-body problem (nucleus as a system of Z protons and N neutrons). The bridges illustrate major physics challenges: the mechanism of quark confinement, the understanding of the bare nucleon-nucleon interaction in terms of the quark-gluon dynamics, and the understanding of the effective interactions in heavy nuclei in terms of the bare force.

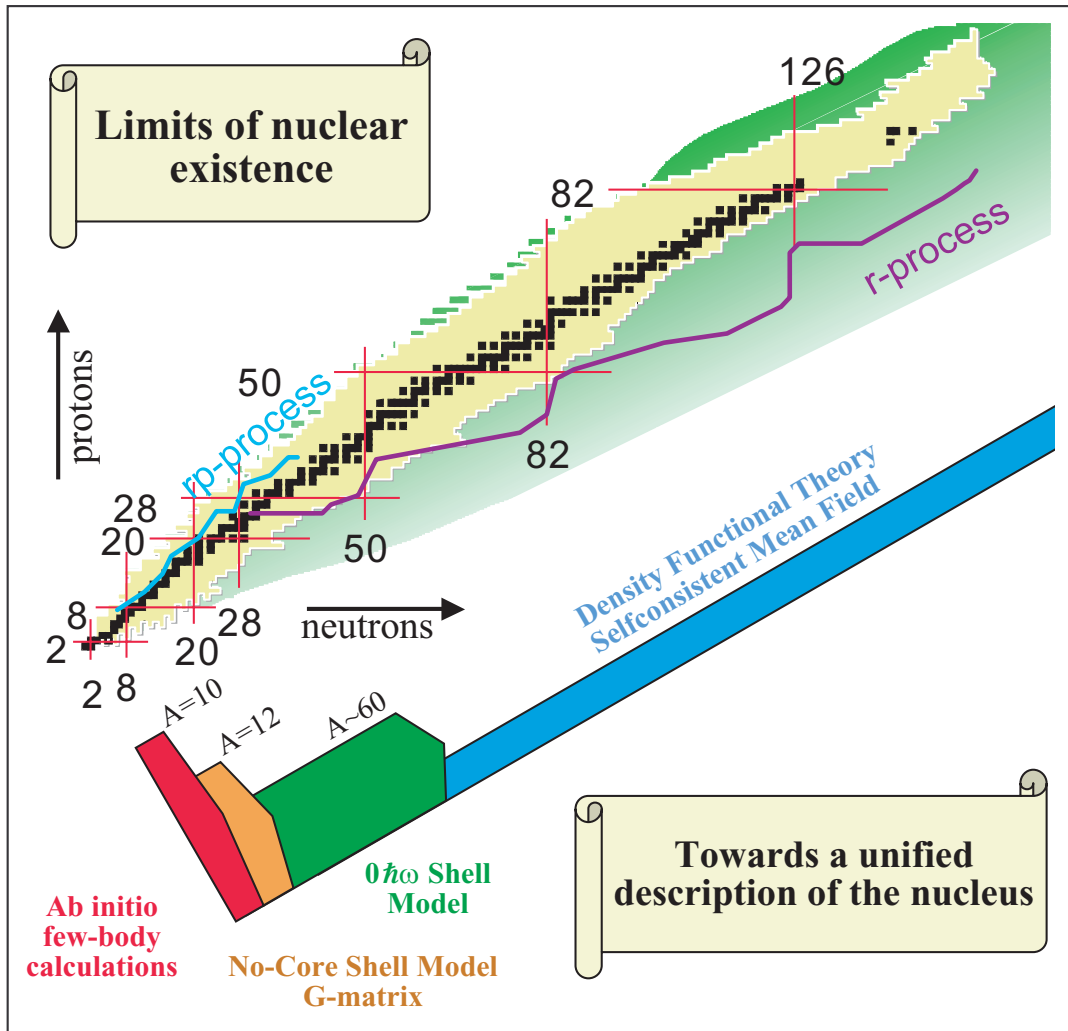

Figure 2: Top: the nuclear landscape - the territory of RIA physics. The black squares represent the stable nuclei and the nuclei with half-lives comparable to or longer than the age of the Earth (4.5 billion years). These nuclei form the "valley of stability". The yellow region indicates shorter lived nuclei that have been produced and studied in laboratories. By adding either protons or neutrons one moves away from the valley of stability, finally reaching the drip lines where the nuclear binding ends because the forces between neutrons and protons are no longer strong enough to hold these particles together. Many thousands of radioactive nuclei with very small or very large N/Z ratios are yet to be explored. In the (N,Z) landscape, they form the terra incognita indicated in green. The proton drip line is already relatively well delineated experimentally up to $Z=83$. In contrast, the neutron drip line is considerably further from the valley of stability and harder to approach. Except for the lightest nuclei where it has been reached experimentally, the neutron drip line has to be estimated on the basis of nuclear models - hence it is very uncertain due to the dramatic extrapolations involved. The red vertical and horizontal lines show the magic numbers around the valley of stability. The anticipated paths of astrophysical processes (r-process, purple line; rp-process, turquoise line) are shown. Bottom: various theoretical approaches to the nuclear many-body problem. For the lightest nuclei, ab initio calculations (Green's Function Monte Carlo, no-core shell model) based on the bare nucleon-nucleon interaction, are possible. Medium-mass nuclei can be treated by the large-scale shell model. For heavy nuclei, the density functional theory (based on selfconsistent mean field) is the tool of choice. By investigating the intersections between these theoretical strategies, one aims at nothing less than developing the unified description of the nucleus.

The first of these concerns the structure of atomic nuclei themselves and of the interactions in the nuclear medium (i.e., effective interactions) that determine their existence and properties. RIA will define and map the limits of nuclear existence and allow us to explore the structure of the exotic quantal systems that inhabit these boundaries. The expanded horizons of nuclei accessible with RIA will provide a nuclear "gene pool" that allows us to select specific nuclei or nuclear reactions that isolate, amplify, or reveal new phenomena, new types of nucleonic aggregations, or key nuclear interactions in ways that beams of stable nuclei cannot do. Moreover, reactions with neutron rich nuclei will help elucidate the nuclear equation of state (EOS), with astrophysical ramifications for the structure of neutron stars and supernovae.

The second concerns our own origins and an understanding of the most cataclysmic cosmic events since the Big Bang. RIA will provide key data, such as masses, lifetimes, and reaction rates, needed for a quantitative understanding of the important nucleosynthesis processes, especially the r-process.

The third concerns our understanding of basic laws of nature and basic interactions among the fundamental constituents of our Universe. With RIA it will be possible to advance the study of CP and P violation, and to carry out new experimental tests of the unitarity of the CKM matrix and of interactions beyond V-A.

Nuclei are unique quantum Fermi droplets in that they are composed of two main components, neutrons and

protons. RIA will make it possible to study these two-component Fermi systems as the proton-neutron asymmetry is varied over a broad range in a controlled way. This physics has strong intellectual links to that of other finite quantum systems: atomic and metal clusters, Fullerenes and other macromolecules, quantum dots, and Bose condensates. As has been the case in the past, understanding the nuclear system will impact our understanding of all finite quantum systems.

Given the compelling physics of exotic nuclei, it is hardly surprising that the two major research areas in the world outside the US, namely Europe and Japan, are already allocating significant resources to advanced exotic beam facilities. However, the capabilities of RIA would far exceed any facility that is now on the horizon.

Indeed, RIA is a bold new concept in exotic beam facilities (see Fig. 3). It combines the key advantages of the two rare isotope production techniques: projectile fragmentation or fission with in-flight separation; and target spallation or neutron-induced fission with isotope separation. The first process provides fast beams for direct use in experiments. By coupling to a post accelerator, both processes yield a wide variety of re-accelerated beams.

RIA's driver accelerator is a flexible device capable of providing beams from protons to uranium at energies of at least 400 MeV per nucleon at power deposition rates of at least 100 kW. With this flexibility, the production method can be chosen to optimize the yield of a desired isotope. The high

Simplified Schematic Layout of the Rare Isotope Accelerator (RIA) Facility

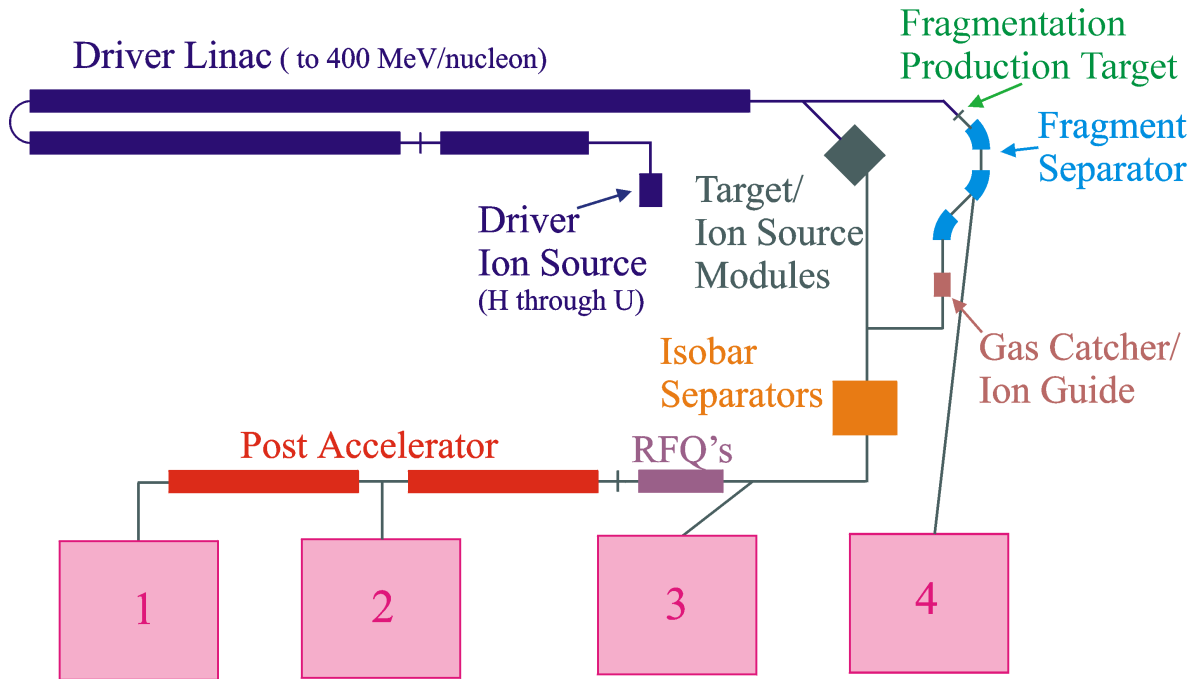

Experimental Areas:

1: $< 12 \text{ MeV/u}$ 2: $< 1.5 \text{ MeV/u}$ 3: Nonaccelerated 4: In-flight fragments

Figure 3: Simplified schematic layout of the Rare Isotope Accelerator (RIA) Facility. Rare isotopes at rest in the laboratory will be produced by conventional ISOL target fragmentation, spallation, or fission techniques and, in addition, by projectile fragmentation/fission and stopping in a gas cell. Upon extraction, these stopped isotopes can be used at rest for experiments in Area 3, or they can be accelerated either to energies below the Coulomb barrier and used in Area 2 or around the Coulomb barrier and used in Area 1. The fast beams of rare isotopes, which are produced by projectile fragmentation/fission, can also be used directly after separation in a high-resolution fragment separator (Area 4). Thus, RIA combines the advantages of both techniques, the conventional thick-target ISOL technique and the transmission-target projectile fragmentation/fission technique.

power provides orders of magnitude improvement in isotope yield over existing or planned facilities.

The extraction of exotic nuclei embodies three methods. In the first method, a thick ISOL-type target is followed by an ion source and post-acceleration up to energies beyond the Coulomb barrier. This method provides the most intense re-accelerated beams of those elements with favorable chemistry for rapid release. A second target area utilizes a thinner target and embodies a twin-mode approach that combines features of both the in-flight and ISOL methods. In one mode, intense beams of short lived isotopes or elements that are difficult to obtain from the standard ISOL target can be obtained with an innovative method that exploits the speed and element independence of in-flight extraction. In this ISOL method the fast mass-separated exotic nuclei are energy degraded and then stopped in a gas catcher from which they can be rapidly extracted for re-acceleration in the post-accelerator. In the other mode of thin target operation, after mass separation, the ions from this target can be used directly as fast beams for experiments at high energies. In all cases, stopped nuclei can also be used for decay experiments or injected into advanced trap devices for nuclear (e.g., mass) or fundamental measurements, or they can be accelerated to low energies suitable for astrophysics studies.

Expected mass-separated intensities from RIA are shown in Fig. 4. Many of these nuclei have never before been available as re-accelerated beams. Generally, *their intensities will be more than two orders of magnitude greater than with any existing or currently*

planned facility. Examples of the unsurpassed discovery potential of RIA will be given in the more detailed discussions to follow this Introduction. We note here only one particular aspect, namely, the great extent of production on the neutron rich side, encompassing most of the r-process path.

These enhanced capabilities will have a profound impact on our study of atomic nuclei. They will, of course, give us access to wholly new nuclei and nuclear excitation modes that have so far been inaccessible. Many of these will be at the extremes of nuclear existence and therefore of prime interest for the discovery and study of new phenomena and of the most exotic nuclear systems. However, closer to stability, such a facility will also produce orders of magnitude more beam than previously available. The power of RIA lies, therefore, not only in the new nuclei it provides but also in the physics it enables for species already available.

In closing this Introduction, we note that there will be diverse opportunities to exploit the nuclei produced at RIA for many kinds of applications. A number of these will occur in medicine (for diagnosis, therapy, and even in surgery) where the ability to tailor the choice of particular isotopes, with appropriate decay modes, lifetimes, and chemical properties greatly expands the choice available today. In electronics, materials science, and surface studies, the ability to soft-land or internally dope various materials with selected exotic nuclei whose chemical properties are time dependent, opens new areas of study. Other applications include monitoring of industrial processing, oil exploration and safeguards areas. A detailed discussion

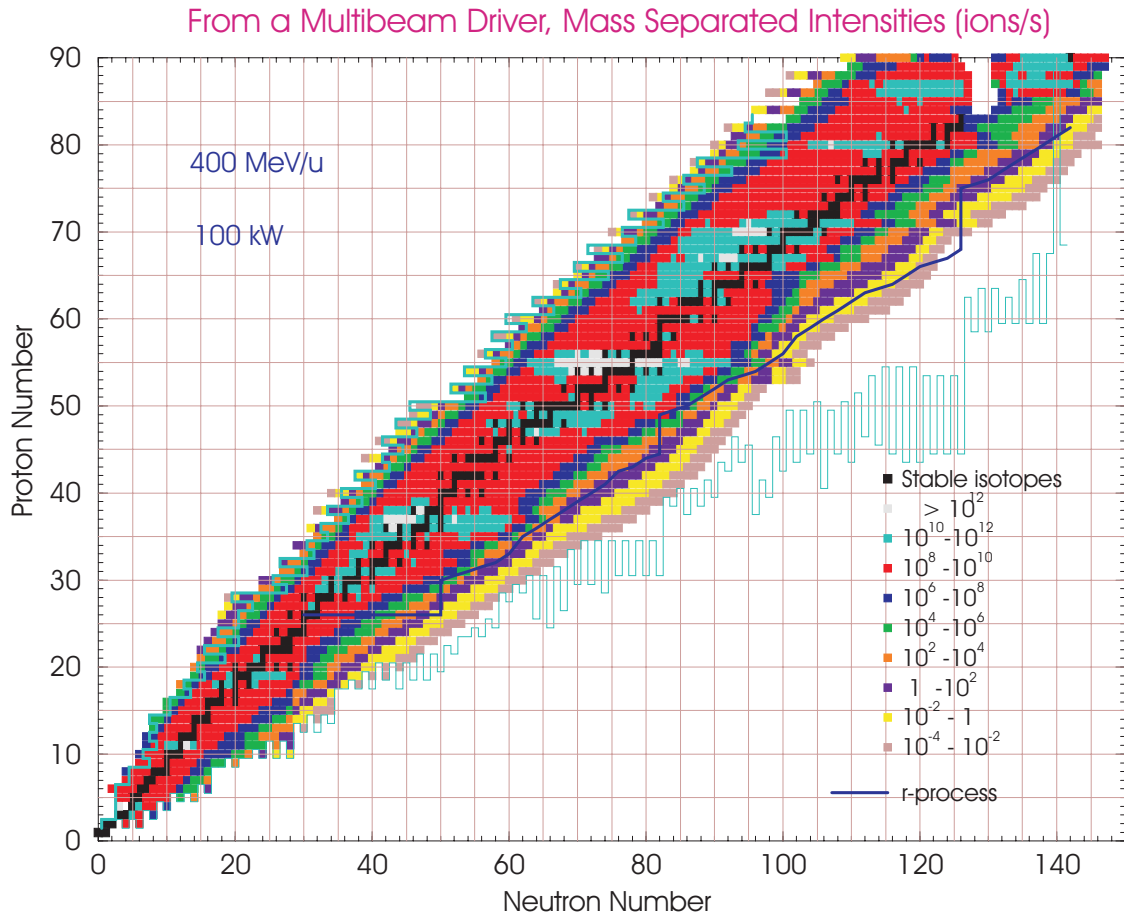

Figure 4: Estimates of the yields of rare isotopes of various elements that will be available at RIA. The intensities are given in ions/s. Each colored square in the figure represents a nuclide. (Private communication from Cheng-lie Jiang and collaborators from ANL and MSU.)

of such applications is beyond the scope of this document.

In summary, it is the comprehensive nature of the RIA concept that makes the discovery potential of this facility enormous. RIA can provide beams of an unprecedented range of nuclei at un-

equaled intensities. Consequently, we can specifically tailor the beam species, beam energies, and nuclear reactions to the particular problem at hand. In the following, we will provide examples of how this will advance the frontiers of our science into exciting new areas that lie beyond the experimental reach of all present and planned facilities.

THE NATURE OF NUCLEONIC MATTER

Hadronic matter in our world is stable only in the form of protons and in the limited number of proton-neutron combinations found in stable nuclei. Beyond the range of stable proton-neutron combinations, there lies a vast domain of nucleonic matter, which is stable against spontaneous disintegration by nucleon emission, but can decay due to the weak interaction and other processes such as α decay or spontaneous fission. We lack a fully microscopic understanding of why hadronic matter is constrained in this way. Indeed, different models predict very different spans of particle-stable nuclei.

Nuclei at the extremes of binding can exhibit behavior which is very different from what is presently known. The stability of these unique many-body systems depends not only on the interplay of the strong, Coulomb, and weak forces but also on other properties such as the single-particle orbits and correlations of the valence (least bound) nucleons.

Exploring and understanding the properties of nucleonic matter is an essential aspect of contemporary physics: The existence and properties of nuclei are fundamental to our understanding of Nature and the world around us. RIA will allow us to explore this new domain of nuclear science in a number of ways. It will allow us to study weakly bound systems which exhibit new forms of nuclear matter, and investigate how the asymmetry in proton and neutron Fermi surfaces affects nuclear binding at the edge of stability, nuclear correlations, and shell structure in cold and hot nuclei.

In short, RIA will advance our understanding of

- **The limits of nuclear existence**
- **The dependence of nuclear structure and dynamics on the asymmetry in neutron-proton composition, and new forms of nucleonic matter at extremes of N/Z ratio.**
- **Effective interactions in proton-neutron asymmetric media**

By probing new and exotic nuclear species, RIA will provide the foundations for the understanding of nuclei. It offers the promise to guide the development of a unified theory of the nucleus in which both the familiar properties and excitation modes of nuclei at and near stability, and the exotic structures far from stability, may be encompassed in a single theoretical framework. We first discuss the limits to nuclear binding and then the structure and interactions in proton-neutron asymmetric media.

Limits of Nuclear Existence

One of the main motivations for studying nuclei at the limits of isospin and charge is to obtain further insight into the nature of the strong force that binds a collection of protons and neutrons together to form a nucleus. This question embodies three frontiers, relating to the determination of the proton and neutron drip lines far beyond present knowledge, and to the synthesis of the heaviest elements. At present, the question of which combinations of

protons and neutrons can form a bound nucleus has been fully answered experimentally only for the lightest eight elements. RIA will help further delineate these limits and allow us to explore the structure of these exotic species. This knowledge is not only important in itself, it is also crucial for a deeper understanding of the origin of the elements and the composition of the Universe: Thousands of radioactive isotopes are continually being created in the cosmos, yet less than 300 of these, in which the Fermi levels for protons and neutrons are nearly equal, make up the stable elements found in nature.

Figure 5 illustrates our current knowledge of the limits of nuclear binding at the neutron drip line. The nucleus ^{24}O , with $Z=8$ and $N=16$, is the heaviest oxygen isotope that is stable against particle emission. Surprisingly for existing theory, the strong force does not bind ^{26}O , nor ^{28}O , which would have been a doubly-magic nucleus ($Z=8$ and $N=20$). Yet the mere addition of one proton (to form fluorine) binds at least six more neutrons: The existence of ^{31}F ($Z=9$, $N=22$) has been demonstrated recently and searches for the heavier fluorine isotopes ^{33}F and ^{35}F are being pursued. *RIA will establish the limits of nuclear existence for elements up to manganese ($Z=25$), and, depending on the exact location of the neutron drip line, perhaps again at zirconium ($Z=40$).* For heavier nuclei, RIA will establish nuclear existence along isotopic chains 10 to 20 neutrons beyond the heaviest isotopes identified to date. With its extended reach for neutron-rich nuclei, RIA will provide sufficient intensities to determine basic properties of these nuclei such as their existence, their masses, and their lifetimes which are

essential for our understanding of astrophysical processes, especially the r-process. Moreover, the resulting improvements in our knowledge of the mass surface should allow safer extrapolations of the locations of the drip lines in heavier nuclei even beyond the limits that will be directly accessible experimentally.

The proton drip line for even- Z nuclei has been explored up to nickel ($Z=28$), and a partial delineation is also available between $Z=50$ and $Z=82$. With RIA, for the first time, it will be possible to comprehensively map the proton drip line for odd- Z nuclei and to identify ground state proton emitters up to $Z=93$. The missing even- Z nuclei, which are hard to reach with current accelerators, will be produced directly as RIA beams. Of particular importance here are the $N=Z$ nuclei with masses $60 < A < 100$, where protons and neutrons occupy the same orbitals, giving rise to the possible formation of a new superconducting phase carried by proton-neutron Cooper pairs which can be studied through transfer reactions with RIA beams. Another fascinating phenomenon of this frontier is proton radioactivity, a clean manifestation of quantum mechanical tunneling through the Coulomb-plus-centrifugal barrier in three dimensional systems where the preformation process that complicates the interpretation of α decay is absent.

Nuclear existence is also limited by the disruptive influence of electrostatic repulsion, which sets an upper bound to the number of protons a nucleus can contain. Which combinations of N and Z might lead to superheavy nuclei depends critically on a subtle interplay between the repulsive Coulomb force

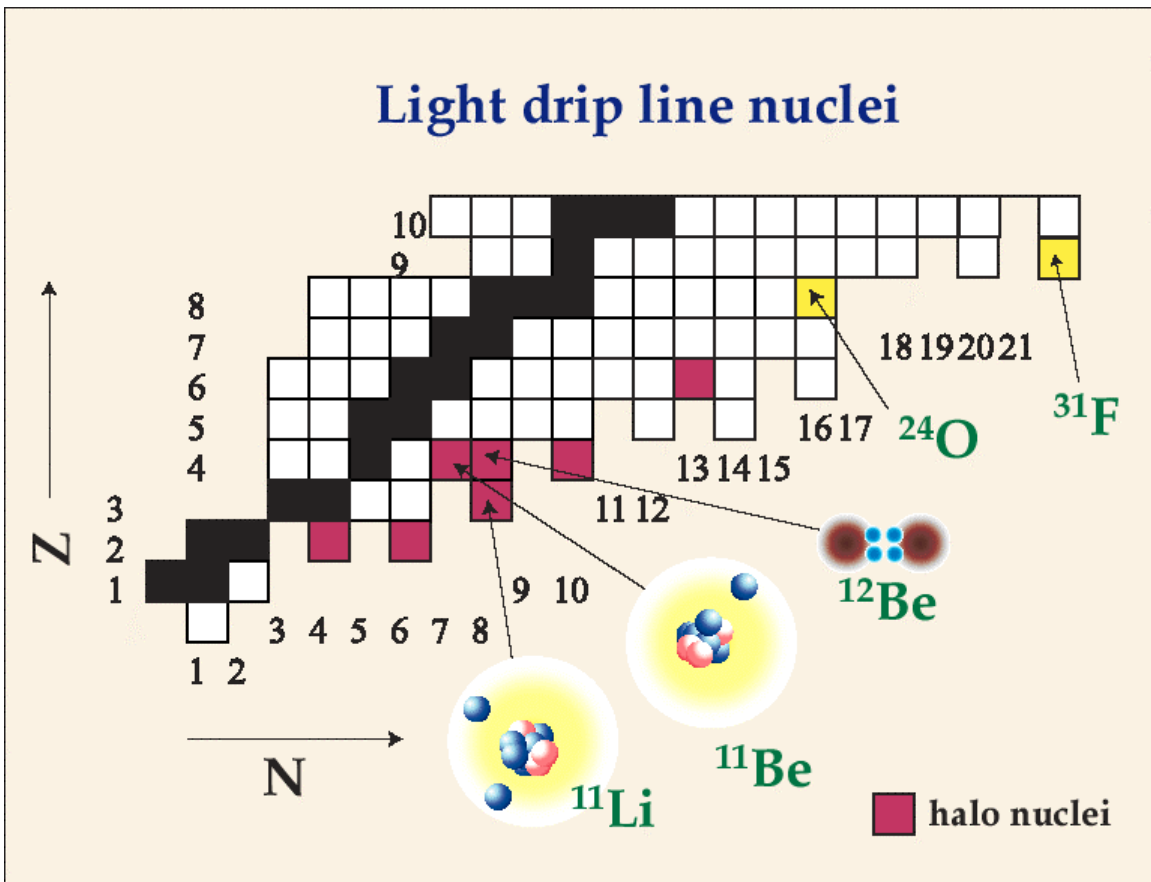

Figure 5: The part of the (N,Z) chart for the lightest nuclei. The neutron drip line has been reached only up to oxygen ($Z = 8$) where the heaviest particle-stable isotope has 16 neutrons. Interestingly, the heaviest isotope of fluorine ($Z=9$) known has 22 neutrons. That is, one additional proton binds at least six neutrons. Known halo nuclei are marked by red squares. A very elongated "dimer" configuration in ^{12}Be has recently been found at higher excitation energies.

and the added binding due to shell structure.

Today, there is a great deal of uncertainty about the location of the center of stabilizing shells in the superheavy region. In particular, the proton and neutron magic numbers in the heaviest nuclei are a matter of considerable theoretical debate. While non-relativistic models predict $N=184$ and $Z=124-126$ as the next magic gaps above ^{208}Pb , relativistic theory favors $N=172$ and $Z=120$. By measuring masses of superheavy nuclei, one will be able to resolve this puzzle, which will help determine the form of the spin-orbit interaction in heavy nuclei.

The limits of stability for heavy nuclei are influenced by the potential barrier to spontaneous fission. In many regions, fission barriers are unknown, yet have implications for the existence of both superheavy nuclei and for neutron-rich heavy nuclei. They affect, in turn, the set of nuclei that can be synthesized in the r-process. RIA will allow the entire fission-barrier surface to be mapped for the first time.

Intense beams from RIA will complement studies of the heaviest nuclei with stable beams in at least two ways. First, they will help facilitate the synthesis of many new heavy or superheavy nuclei. Secondly, the new superheavy elements created in fusion reactions with stable beams are usually identified by their α decay chains. However, these chains have end points in a region of the nuclear chart not accessible with stable beams. The fusion of re-accelerated beams of neutron-rich isotopes from RIA, with ^{208}Pb , ^{238}U , and ^{248}Cm targets,

will take us to the region of shell stability and will allow exploration of many of the nuclei which are part of these decay chains, thus putting the identification of superheavy elements on a solid experimental footing.

Structure and Interactions in Proton-Neutron Asymmetric Media

A common theme in nuclear structure concerns the interactions that cluster protons and neutrons together into a nucleus. Our strategy in the quest to understand the nuclear force in the context of the hadronic and nucleonic many-body problem was shown in Fig. 1. The free nucleon-nucleon (NN) interaction results from the quark-gluon dynamics of QCD, similar to the intermolecular forces that stem from QED. In many-body nuclear systems, due to the presence of the nucleonic medium, the effective NN interaction differs considerably from the free one; its form depends sensitively on such factors as the number of nucleons, the neutron-proton asymmetry (isospin), and the density of the medium.

Significant advances in microscopic modeling of nuclear structure have been made in recent years, due to both new algorithms and to tremendous increases in computational power. The “ab initio” work on few-nucleon systems, based on the free NN interaction, augmented by a three-body force, allows us to predict the properties of nuclei with $A \leq 10$. The currently developed no-core shell model, employing the effective interaction microscopically derived from the free

force, has already reached ^{12}C . For heavier nuclei, various shell model methods utilizing sophisticated truncation schemes have been very successful in predicting nuclear properties. The effective interactions developed in shell model studies can be used to understand the density-dependent forces employed by the mean-field methods applied to heavy nuclei. Figure 2 includes a schematic illustration of this hierarchy of theoretical models spanning the chart of the nuclides. By exploring connections between these models, nuclear theory aims to develop a unified description of the nucleus.

However, at present, our understanding of the effective interaction is limited and probably flawed because it has been developed mostly from studies of nuclei close to the valley of stability. In models aiming to predict the properties of all nuclei, important questions that arise are: What is the form of the bare three body interaction in light nuclei? What is the isovector (density) dependence of the effective force? What is the form of the spin-orbit interaction? What is the role of in-medium effects and core polarization in the low-density region? Similar questions are asked in connection with properties of nuclear matter, neutron droplets, and neutron stars.

Figure 6 illustrates difficulties with making theoretical extrapolations into the neutron-rich “terra incognita”. It shows the two-neutron separation energies for the even-even Sn isotopes calculated in several microscopic models based on different effective interactions and, in the inset, those obtained with phenomenological mass formulae. While all these models nicely describe the existing experimental data for $N \leq 82$,

there are appreciable differences for heavier systems. In addition to revealing our lack of a comprehensive nuclear model covering the entire nuclear chart, the inability to extrapolate is a serious problem in the context of astrophysical processes whose paths go through unknown regions of the nuclear chart.

The cornerstone of nuclear structure for over half a century has been the concept of single particle motion in a well-defined potential, leading to shell structure and magic numbers, and of residual interactions that generate configuration mixing. Electron scattering knock-out studies have demonstrated that this picture breaks down due to short-range correlations. Experiments on exotic nuclei are beginning to suggest even further limitations to the concept of single particle motion.

We now appreciate more deeply that the weak binding, inherent to nuclei approaching the drip lines, has a profound influence on nuclear properties and on none more so than the underlying shell structure. The bunching of the energy levels that is endemic to shell structure depends on the form and the shape of the average mean field potential in which the hadrons are moving. With a diffuse surface region, the spin-orbit force may be weakened. Some calculations indicate that, near the neutron drip line, one may encounter quenching of existing shell gaps or perhaps even the emergence of new magic numbers (see Fig. 7). Moreover, residual interactions in this modified mean field, such as the p-n interaction, or the pairing field, are expected to be different from their counterparts near stability. It has been suggested that, in a weakly bound neutron-rich nucleus, the

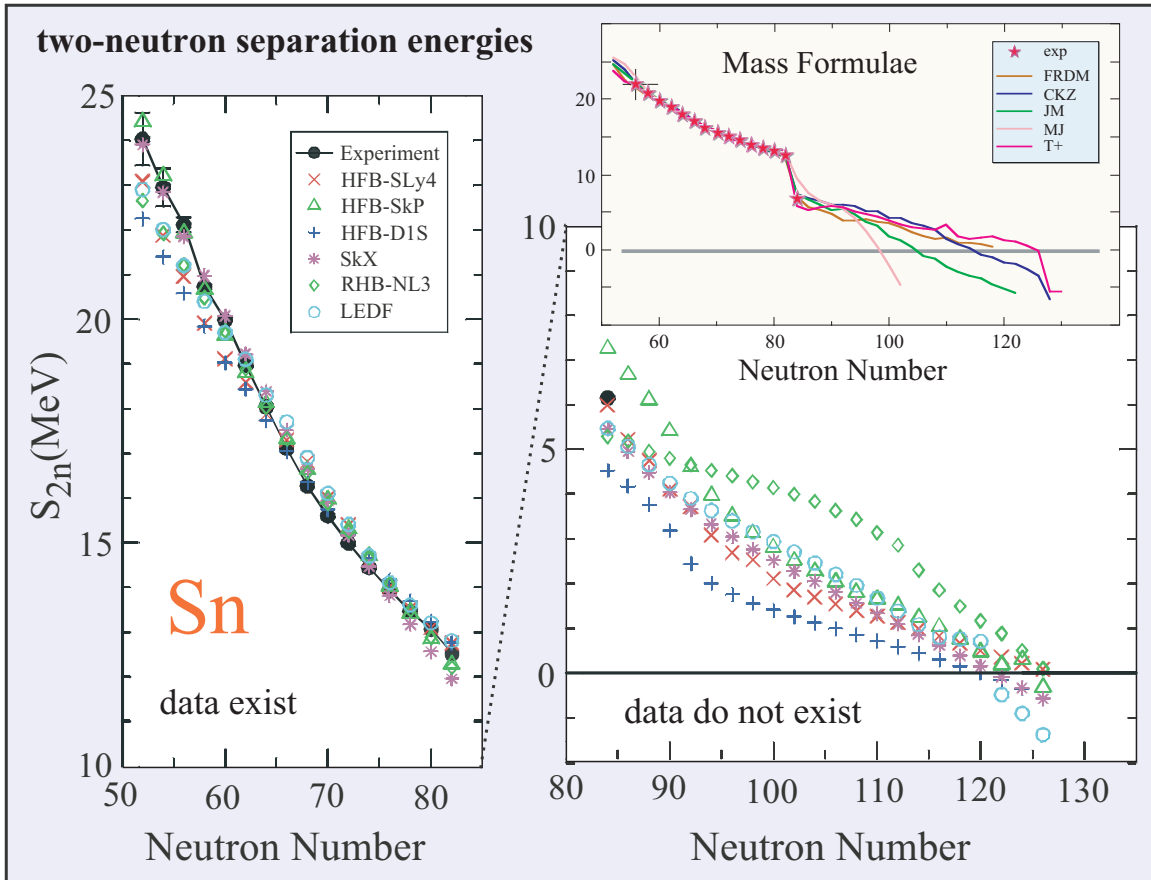

Figure 6: Predicted two-neutron separation energies for the even-even Sn isotopes using several microscopic models based on effective nucleon-nucleon interactions and obtained with phenomenological mass formulas (shown in the inset). While calculations agree well in the region where experimental data are available, they diverge for neutron-rich isotopes with $N > 82$. It is seen that the position of the neutron drip line is uncertain. Unknown nuclear deformations or as yet uncharacterized phenomena, such as the presence of neutron halos or neutron skins, make theoretical predictions highly uncertain. Experiments for the Sn isotopes with $N = 80 - 100$ will greatly narrow the choice of viable models.

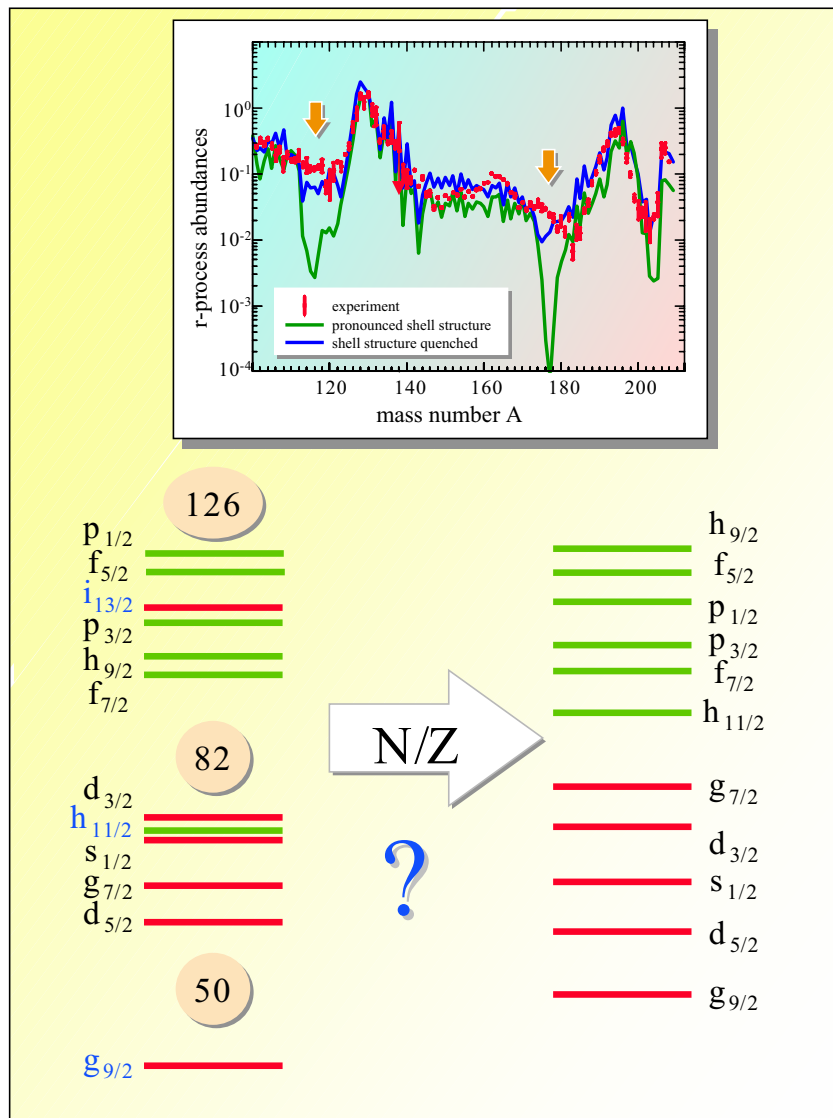

Figure 7: Left: Spherical shell structure characteristic of nuclei close to the valley of stability. Nuclear shells, the bunches of close-lying single-particle levels, are separated by magic gaps. Right: Neutron shell structure predicted for neutron-rich nuclei, corresponding to a shallow mean-field potential and significantly reduced spin-orbit coupling. The very neutron rich drip line nuclei cannot be reached experimentally under present laboratory conditions. On the other hand, these systems are the building blocks of the astrophysical r-process; their separation energies, decay rates, and neutron capture cross sections are the basic quantities determining the results of nuclear reaction network calculations. The properties of very neutron-rich nuclei are thus linked to the r-process component of the solar system abundances of heavy elements, shown in the inset. The red squares with error bars indicate the experimentally deduced r-process abundances for nuclei with mass numbers greater than $A=100$. The theoretical abundances, marked by green and blue, were obtained in r-process network calculations Pfeiffer et al. [Z. Phys. A357, 235 (1997)]. They are based on microscopic mass formulae which assume that the spherical shell gaps towards the neutron drip line are either similar to those in stable nuclei (green curve) or significantly quenched (blue curve). It is seen that calculations that incorporate a quenching of magic gaps at $N=82$ and $N=126$ greatly improve our ability to understand the experimental solar abundances of the elements around $A=118$ and 178 , and above 200 .

pairing interaction and the presence of skin excitations might invalidate the picture of a nucleon moving in a single-particle orbit.

RIA provides the opportunity to address these issues by probing how key concepts of nuclear structure such as independent particle motion, the occurrence of magic numbers, the role played by correlations, and formulations of effective interactions evolve with isospin. In particular, *the intense beams of RIA will allow unparalleled access to specific nuclei whose structure allows the amplification and isolation of those components of the effective interaction and those features of nucleonic correlations that depend most sensitively on the neutron-to-proton ratio.*

In order to evaluate accurately the alterations to shell structure and many-body correlations, it is important to study them not only at the extremes of accessibility, but well inside the drip lines as well. Direct single nucleon and pair transfer reactions with beams re-accelerated to energies above the Coulomb barrier will allow such studies to be systematically pursued. RIA will offer unprecedented avenues to extend our knowledge of nucleonic correlations, collective modes, new phases of nuclear superconductivity, phase transitional behavior in nuclei, and the way structure evolves with nucleon number, by techniques such as multiple Coulomb excitation with re-accelerated beams, single step Coulomb excitation with both fast and low energy beams, and β -decay of stopped nuclei.

Very close to the neutron drip line, nuclear binding decreases and the

valence neutrons occupy orbits that have large spatial extensions. The study of the physics of the low-density zone of nearly pure neutron matter is still in its infancy, yet has already yielded surprises. In light nuclei, neutron halos, with radii several times larger than those of stable nuclei of the same mass, have already been seen. In heavy nuclei, neutron skins have been predicted.

Halo nuclei offer us opportunities for new physics. On the one hand, the loosely bound halo neutrons move almost freely, and their interaction is close to the bare interaction. On the other, the presence of these halos will also give rise to new types of collective excitations (such as the oscillation of the halo against the core - called the pigmy resonance). The intensities provided by RIA ensure that halo nuclei in the vicinity of the drip line will be accessible to experiment, not only up to mass $A \sim 50$ where firm theoretical predictions exist, but also for nuclei with mass closer to $A \sim 100$, where the existence of such structures is a matter of much theoretical debate. Here, for example, knock out and Coulomb dissociation reactions will be important tools.

While a halo is a threshold effect of weak binding, the large N/Z ratio in heavier neutron rich nuclei implies the presence of an excess of neutrons at large distances; i.e., a bulk phenomenon of a neutron skin which can be studied with RIA beams. This can be done by investigating the evolution of structure along a small number of selected isotopic chains where large differences in N/Z ratios will be available. The Ni isotopes that will be accessible with RIA

contain four magic numbers and span five major shells. The Zn, Kr or Zr chains are also good candidates since nuclei with as many as 20 neutrons beyond stability can be explored.

Effective interactions and nuclear dynamics in hot matter can be probed by means of intermediate-energy nuclear reactions. Nuclear matter can be compressed to densities of more than twice the saturation density during nucleus-nucleus collisions at energies of 300-400 MeV per nucleon. RIA will provide unique opportunities for the study of dense nuclear matter. No other means exists to prepare matter at such densities under laboratory-controlled conditions. Investigations of the pressure-density-temperature relationship, i.e., the EOS of high-density matter, have primarily utilized observables constructed from the momenta of particles originating from the high-pressure, high-density region. The analysis has eliminated several models that employ either very soft or very stiff equations of state. The data, when confronted by model dependent analyses, strongly favor incompressibilities in the range of $K=180-310$ MeV. Previous investigations have concentrated primarily on the isoscalar incompressibility of the nuclear matter EOS, leaving the isovector dependence, i.e., the dependence on the difference between neutron and proton densities, largely unexplored.

RIA will provide a unique capability for compressing neutron-rich matter and studying the isospin dependence of the EOS. The density dependence of the asymmetry energy term of the EOS has

large uncertainties. This term plays a critical role in neutron stars where it supplies most of the pressure supporting the star at densities less than twice the saturation density and influences, among other properties, neutron star density profiles and the mass boundary between neutron stars and black holes. Predictions for the total energy released during a type II supernova collapse and its time dependence are also strongly influenced by the asymmetry term. Sensitivity to this term has been predicted for a number of observables that could be measured in nucleus-nucleus collisions at RIA at intermediate energies.

To conclude the discussion in this section, we stress that the opportunities presented here concentrate on some of the most exciting physics dealing with new forms of nuclear matter that can be formed and studied only at a facility like RIA. However, by its very nature as a complex strongly interacting quantum system, the nucleus exhibits a richness of dynamics and phenomena that could not be fully covered here. Examples include the search for exotic nuclear shapes, such as hyperdeformation, low-lying isomeric states, investigations of the transition from "order to chaos", systematic measurements of level densities, and studies of multifragmentation and pre-equilibrium phenomena. In all cases, experiments will benefit from the unique capabilities of RIA which enable the limits of angular momentum and temperature to be explored, in addition to those of isospin and mass addressed here.

THE ORIGIN OF THE ELEMENTS AND ENERGY GENERATION IN STARS

Advances in Earth and space-based astronomical observatories have provided us an unprecedented view of our Universe. A key to the quantitative understanding of these new observations is the determination of nuclear properties that affect energy generation and element synthesis in the Cosmos. This is the purview of Nuclear Astrophysics.

Nuclear Astrophysics is a broad interdisciplinary field that ties microscopic nuclear and particle physics with macroscopic stellar and cosmological events. It involves the physics of nuclear matter, the understanding of nuclear reaction mechanisms, the evolution of nuclear structure, and the contributions of strong and weak interaction processes resulting in stellar nucleosynthesis and energy generation. The strong interaction and nuclear reaction processes determine the time scales of stellar evolution and the origin of the chemical elements in our universe, while weak interaction processes are closely associated with the physics of core collapse type II supernovae. Nuclear reactions on unstable short-lived species determine the time scale, the energy release, and the ensuing nucleosynthesis in violent stellar explosions. The supernovae shock front driven through the outer layers of a presupernovae star, thermonuclear explosions on the surface of accreting white dwarf stars or neutron stars, and rapid burning in the accretion disks of black holes are only some of the sites where nucleosynthesis proceeds far away from the line of stability.

Many of the signatures for the nature and characteristics of stellar explosions are based on the observations from instruments such as the HUBBLE telescope (see Fig. 8). One set of observations revealed new aspects of one of the most fundamental nucleosynthesis processes, the r-process, which is responsible for the origin of more than half of the nuclei heavier than iron. We also have new insights on nucleosynthesis in accreting white dwarfs (novae) from the observations of the abundances of freshly formed isotopes in the ejected material seen by the recently launched CHANDRA x-ray telescope. Satellite based x-ray telescopes also show new indications for thermonuclear explosions in x-ray bursts and x-ray pulsars. Galactic radioactivity gives evidence for the origin of radioactive nuclei in supernovae and novae explosions. The new INTEGRAL gamma observatory will multiply the number of observed sites and provide much more detailed evidence for the path of nucleosynthesis in stellar explosions.

While the observational evidence has multiplied over the last decade, our deeper understanding of the nature of these explosive events (including their residual radioactivity and the origin and details of the observed time structure of their luminosity) is still in its infancy. The theoretical models for stellar explosions often must be based on global assumptions about nuclear masses, decays, and level structure since the necessary nuclear data do not exist.

Nuclear Astrophysics with RIA

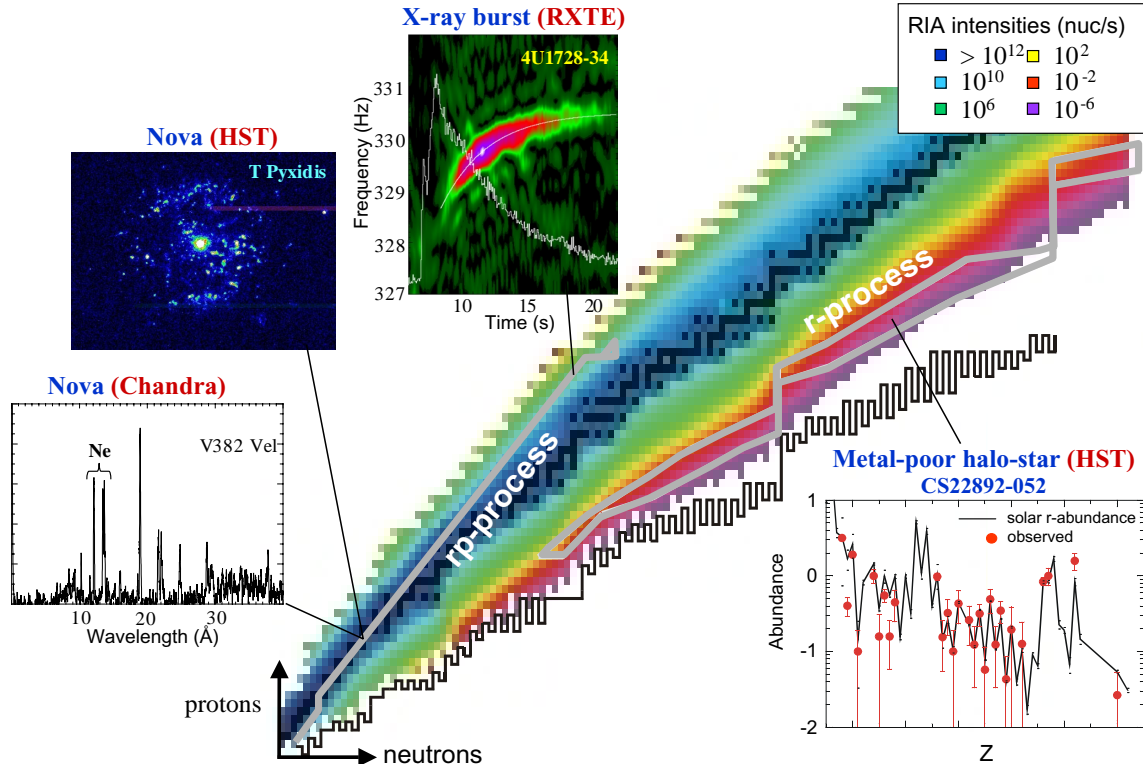

Figure 8: An N vs. Z chart highlighted by some of the areas relevant to a variety of explosive astrophysical scenarios, as measured in satellite observatories: rp-processing of light nuclei in nova explosions as observed in Hubble optical images and in Chandra x-ray spectra; on the surface of an accreting neutron star rotating with a period of 3 msec, an x-ray burst (with a 1 sec risetime) powered by the rp-processing of medium mass nuclei, as measured using the Rossi x-ray Timing Explorer; a remarkable comparison of the r-process abundance distributions for the solar system and for a very old, very metal poor star in the galactic halo, as determined by measuring its optical spectra with the HST.

More refined nuclear properties are needed as input to the models to allow the quantitative comparison of observations with model predictions, and to achieve a better understanding of the nature of these events. In particular, RIA will allow the quantitative study of both:

- **The astrophysical rapid neutron capture process (r-process)**
- **The astrophysical rapid proton capture process (rp-process)**

By giving us access to the requisite nuclear structure information, the construction of RIA will provide a necessary tool to investigate the physics of nucleosynthesis and explosive events in the Cosmos.

r-Process

The r-process, together with the slow neutron capture process (the s-process), is a dominant nucleosynthetic mechanism for heavy elements above iron. In the r-process the rapid capture of neutrons leads, starting from a seed nucleus (e.g., ^{56}Fe), to heavier and heavier isotopes until a nucleus is reached, whose neutron binding energy is so small that the capture rate is balanced by photo-disintegration. At this point, the neutron capture process stops and the nucleus has to wait for a β -decay leading to an element with higher neutron separation energy where the capture process can start again. Nuclei with neutron magic numbers, therefore, tend to be 'waiting points', where the neutron capture hesitates and β -decay towards stability predominates. This results in the maxima observed in the cosmic element abundances at certain mass numbers. The deduced r-process

abundance distribution is, therefore, one of Nature's signatures for the existence of shell structure in very neutron-rich nuclei. In particular, quenching of shell structure, discussed in the previous section, can have a dramatic effect on calculated abundances (see Fig. 7).

The site for the r-process is still under debate. Neutrino driven winds in supernovae or merging neutron stars are two of the proposed environments. Present models of the r-process are based on global calculations for characteristics of very neutron rich nuclei. Recent experiments with first generation exotic beam facilities have revealed significant discrepancies with predicted nuclear properties such as masses, decays, resonance energies, and shell structure.

Recent HUBBLE telescope observations of very old stars in the Galactic Halo find an r-process abundance distribution which is in strikingly good agreement with the distribution of solar system abundances for heavy nuclei, $A > 120$, but which deviates from the solar distribution for $A < 120$. This seems to indicate a second r-process may be responsible for these lighter elements, under different macroscopic conditions. Unfolding the second component will require better nuclear structure data to determine the difference between these two r-processes.

As proposed, *RIA will be the world's only facility with enough intensity for the variety of beams needed to carry out measurements of the masses, lifetimes, and decays of most r-process nuclei, and to study the impact of long-lived isomeric states in nuclei along the r-process path.* Data from RIA will help reduce microscopic uncertainties in

modeling the r-process and would thereby allow us to use r-process signatures as tools to probe the macroscopic conditions in which this process occurs and to thereby succeed in the long standing search for the astrophysical site of the r-process.

rp-Process

Novae and x-ray bursts are the most common explosive astrophysical events and, thus, have been studied extensively with both ground and space-based telescopes. These events occur, as do Type Ia supernovae, in binary systems where one of the objects is a white dwarf or a neutron star. Due to their strong gravitational potential, these compact objects accumulate hydrogen and helium from their companion star onto their surfaces where it is ignited, once sufficient material has piled up. At low accretion rates on a white dwarf this triggers a nova explosion, while high accretion rates trigger a Type Ia supernova. Low accretion rates on a neutron star result in x-ray bursts lasting typically tens of seconds. All these events involve nuclear reactions at high temperatures ($>10^8$ K) and high densities and are responsible for the synthesis of a considerable fraction of the elements with masses above oxygen.

Novae are potential producers of ^{18}F , ^{22}Na , and ^{26}Al , which are sources of observed galactic gamma rays. Modeling of their nucleosynthesis requires reaction rates for proton and α capture processes on light neutron deficient nuclei. The experiments are extremely difficult and require beam intensities of up to 10^{12} particles per second. For many of these isotopes, RIA will be able to provide this level of

beam intensity. RIA also offers the capability to use complementary indirect methods such as single particle transfer or Coulomb dissociation to determine some reaction components that are not accessible to direct experiment. Reliable experimentally measured reaction rates will allow the detailed simulation of nucleosynthesis to be compared with the observational results and offer the opportunity to probe directly the macroscopic conditions in extreme thermonuclear explosions.

The phenomena of x-ray bursts and x-ray pulsars are interpreted as thermonuclear explosions in the accreted hydrogen and/or helium rich layers of neutron stars. These events offer the opportunity to study nucleosynthesis at extreme temperature and density conditions on a time scale of only a few seconds and to obtain information on neutron star properties. The ignition of this thermonuclear runaway depends on the break-out reactions from the hot CNO cycles; the time scale for the energy release depends on alpha and proton capture reactions and beta decay processes near the reaction path. The peak of the energy generation is associated with the doubly closed shell nucleus ^{56}Ni . The endpoint of the rp-process depends on subtleties of nuclear structure near the $N=Z$ line, and is most likely linked to the onset of alpha decay from the neutron deficient Te isotopes back to the $Z=50$ (closed shell) Sn isotopes.

To study the onset of the rp-process, reaction rate information is necessary, and much of this information can only be garnered with the use of unstable ion beams at RIA. The anticipated cross sections are extremely small and require

high beam intensities. Of extreme importance is the measurement of waiting points along the rp-process path. The predicted 2p-capture process (bridging the limits of particle stability by involving proton capture on proton unstable nuclei) and the prediction of $4^1\text{H} \rightarrow ^4\text{He}$ hydrogen-burning cycles (involving Sn-Sb-Te nuclei) both need to be experimentally verified to determine the fate of hydrogen in the accreted material and the abundance distribution in the ashes, which are being buried by freshly accreted material on the surface of the neutron star. Remaining hydrogen is converted by electron capture to neutrons possibly igniting an r-process in the deeper layers of the neutron star atmosphere. Still deeper, in the neutron star crust, the ashes will be converted by electron capture from neutron deficient

to neutron rich material and will subsequently neutronize by a combination of electron captures and pyconuclear processes along the neutron drip line. These reaction sequences determine observable neutron star properties like the thermal structure of the neutron star crust and the emission of gravitational waves.

To understand nucleosynthesis, and the stellar processes and sites that produce it, it is necessary to perform experiments on nuclei far from stability. RIA will enable us, for the first time, to put our understanding of most of explosive nucleosynthesis and the nature of stellar explosions on a firm experimental basis.

TESTS OF THE STANDARD MODEL AND OF FUNDAMENTAL CONSERVATION LAWS

RIA promises to generate a great variety of radioactive isotopes with high intensities that will provide unprecedented opportunities to search for physics beyond the Electro-Weak Standard Model. *RIA will allow for orders-of-magnitude improvements on limits of the CP-violating atomic Electric Dipole Moment (EDM) and on the determination of the Weinberg angle from measurements of parity violation in Fr atoms.* New measurements of β -decay using ion or atom traps will produce much higher precision for searches for non V-A contributions to the weak interaction. Finally, β -decay measurements, coupled with new information on the spectroscopy and masses of the appropriate nuclei far from stability, could provide definitive information on the apparent non-unitarity of the Cabibbo-Kobayashi-Maskawa (CKM) matrix.

Atomic Electric Dipole Moments

The first experimental observation of CP happened over 30 years ago with the discovery that the neutral kaon system is a mixture of CP eigenstates. Remarkably, CP violation remains one of the most important open issues in fundamental physics. It appears in the Standard Model in two ways: through quark mixing in the CKM matrix and through the gluon field in QCD. Neither of these mechanisms, however, yields CP violation that is consistent with the observed cosmological baryon asymmetry that resulted from the big bang. Many extensions of the Standard

Model that are compatible with the observed baryon asymmetry predict additional CP violating observables. The best probe of CP or T violation for flavor conserving interactions is the measurement of the permanent electric dipole moment of an atom or the neutron. Indeed, supersymmetric theories predict values for the EDM which are just below the present limits.

An atomic EDM arises from a separation of charge along the direction of the total angular momentum. A non-zero EDM is a signal of both T-violation and P-violation. Naively one would expect the nuclear EDM to be cancelled by reaccommodation of electrons. But Schiff has shown that relativistic effects yield a non-zero value for atoms. This Schiff moment is proportional to the product of the nuclear EDM and the mean square charge radius and increases as Z^p ($p \sim 2-3$). Nuclear structure effects can cause a large enhancement of the Schiff moment (for example through octupole deformation).

Rn ($Z=86$) is one of the best new candidates for discovery of EDMs. The atomic transitions in Rn have sufficiently long wavelength (~ 180 nm) that laser measurements will be feasible, and will provide a precision comparable to or better than ^{129}Xe ($Z=54$) and ^{199}Hg ($Z=80$), for which the most precise limits for atomic EDMs have been found. The higher Z provides greater sensitivity to CP violation through the enhanced sensitivity to the Schiff moment. For isotopes having low-lying octupole vibrational excitations or possessing

permanent octupole deformations (e.g., ^{223}Rn), additional enhancement of the Schiff moment by a factor of 100 or more greatly improves the sensitivity to CP violation. In fact, we must find CP violation in more than one new system to separate the Standard Model effect of the gluon field from new physics.

Many experimental issues have to be solved before such experiments can be carried out and initial work is already underway at existing facilities, but all these experiments will be limited by counting rate. RIA should be able to deliver the necessary intensities to achieve the highest precision possible. Other isotopes from RIA may also be promising. As an example, oxide molecules of Ra-isotopes may provide great enhancements of the local electric field around the atom, which could ultimately lead to the most precise measurements of an EDM, i.e., 100-1000 times better than present limits.

Parity Violation

Measurements of atomic parity violation are sensitive to new physics beyond the Standard Model. Indeed, recent measurements of parity violation in Cs ($Z=55$) have re-ignited speculations about the need for extra gauge bosons. But these interpretations depend crucially on atomic-theory calculations, which need to be improved to the 0.1% level to produce significant progress.

Parity violation measurements in Fr ($Z=87$) should be able to provide a more sensitive probe for deviations from the Standard Model than Cs, as electron-nucleus interactions scale approximately as Z^3 . In addition, Fr isotopes can be

studied over a very wide range of neutron number. This would provide a test of the predicted isotopic dependence of the spin-independent interaction. Precise measurements of electromagnetic interactions in atoms are now possible with modern atom trapping methods, and initial measurements with Fr atoms have provided tests of the atomic theory of Fr at the level of 1% with production rates of the order of 10^6 atoms per second. With improvements in trapping methods and higher intensities at RIA (more than 10^8 atoms per second for most isotopes between ^{205}Fr and ^{228}Fr , and up to 10^{11} atoms per second for the most intense), tests at the level of 0.1% will be possible.

An important nuclear physics issue in these results is that the distribution of neutrons within the nucleus must be known with good accuracy. Complementary experiments on parity violation in electron scattering and measurements of the hyperfine anomaly will soon produce additional information that should help to partly overcome this difficulty.

Beyond V-A

Precise measurements of nuclear β -decays were used to establish the V-A character of the weak currents in the 1960's. In recent years there has been renewed interest in such measurements since many extensions of the Standard Model naturally predict non V-A currents, such as right handed currents in left-right symmetric models, and scalar and tensor currents, in super-symmetric and lepto-quark model extensions. In order to determine if any of these extensions of the Standard Model are

correct, one needs to improve the measurements on the non-standard couplings by about an order of magnitude over present limits (~5% of the V-A coupling strength).

Today, experiments are reaching a point where the available intensities of radioactive species are not sufficient to make significant improvements. RIA would provide the necessary intensities to constrain the non V-A couplings to ~0.5%. Similarly, RIA would open the possibility of measuring the shape of β spectra in a systematic manner. Shape factor measurements have depended strongly on special developments to produce very thin sources of a particular isotope. With the high intensities and variety of isotopes available at RIA, it could be possible to perform systematic measurements on a number of isotopes under controlled conditions. This would permit significantly better limits on the interference between axial and tensor currents.

Unitarity of the CKM Matrix

In the Standard Model the weak decays of quarks occur between eigenstates which do not exactly coincide with the quark mass eigenstates. The Cabibbo-Kobayashi-Maskawa (CKM) matrix establishes the relationship between the

weak and mass eigenstates and consequently should be unitary. However, the best current values for the elements of the first row of the CKM matrix imply a unitarity violation at the 0.4-0.5% level with deviation of more than 2.6 sigma. The matrix element V_{ud} is by far the largest and comes from the measured Ft values of nine well-determined 0^- to 0^+ superallowed Fermi-decay transitions.

One important theoretical uncertainty arises from the isospin-mixing correction, δ_C , which must be made to the measured Ft value. In the nuclei that have been studied to date, this correction is typically 0.1-0.5%. The best way to test the calculated values is to study a range of decays with very different calculated values for δ_C . In the $N=Z$, odd-odd nuclei with $A>60$ the corrections are predicted to be <1.5%. This region of medium-mass nuclei is far more difficult to reach with present facilities, and only ^{62}Ga and ^{74}Rb might yield precise results prior to RIA. The orders of magnitude increase in the available intensities possible with RIA will be key to study a broader range of superallowed Fermi transitions with high precision. RIA would also enable studies of the isospin-forbidden 0^- to 0^+ Fermi transitions that are also believed to occur in this region.

APPENDIX

The Workshop in Raleigh-Durham North Carolina, held July 24-26, 2000, was put together by the RIA Steering Group which represents all of the scientific and technical areas of RIA research. The Workshop included a small number of plenary talks and over 12 hours of Working Group discussions. The local planning was carried out by an Organizing Committee comprised of Werner Tornow, Chris Gould, Art Champagne, John Kelly, Carl Brune, and Christian Iliadis. We are very grateful to them for the excellent arrangements and

the smooth flow of the Workshop. Special thanks are also due to their assistants Maria Scripa and Liz Neidel and to Christine O'Connor for preparation of this document. The Program of the Workshop and lists of members of the RIA Steering Group and of the Working Group Conveners are given below. This White Paper, based on drafts provided by the Conveners, was put together by Rick Casten and Witek Nazarewicz with the advice of the RIA Steering Group and the Conveners.

Program for the RIA Workshop

Monday, July 24

8:00-8:30	Registration
8:30-9:00	Casten and Nazarewicz - Welcome
9:00-9:45	Savard - RIA
9:45-10:00	Discussion
10:00-10:45	Haxton - Astrophysics
10:45-11:00	Discussion
11:00-11:30	Coffee
11:30-12:15	Dean - Nuclear Structure
12:15-12:30	Discussion
12:30-14:00	Lunch
14:00-14:45	Freedman - Fundamental Interactions
14:45-15:00	Discussion
15:00-18:45	Working Group Discussions
18:45-19:15	"Reality check" Group meets with Conveners

Tuesday, July 25

8:30-9:00	Short general discussion
9:00-9:45	Lacey - Reactions
9:45-10:00	Discussion
10:00-10:45	Sherrill - Nuclear Structure
10:45-11:00	Discussion
11:00-11:30	Coffee
11:30- 12:30	Views from DOE/NSF and NSAC
12:30-14:00	Lunch
14:00-18:15	Working Group Discussions
20:00-21:00	"Reality Check" Group meets with Convenors

Wednesday, July 26

8:00-10:00	Working Group presentations by Convenors
10:00-10:30	Coffee
10:30-13:00	Discussion
13:00-13:30	Nazarewicz and Casten - Final Remarks

RIA Steering Group

Jim Beene, Oak Ridge National Laboratory

Richard Casten, Yale University (co-chair)

Stuart Freedman, Lawrence Berkeley National Laboratory

Donald Geesaman, Argonne National Laboratory

C. Konrad Gelbke, Michigan State University

Thomas Glasmacher, Michigan State University

Robert Janssens, Argonne National Laboratory

I-Y. Lee, Lawrence Berkeley National Laboratory

Brad Meyer, Clemson University

Witold Nazarewicz, University of Tennessee/ORNL (co-chair)

Eric Ormand, Lawrence Livermore National Laboratory

Mark A. Riley, Florida State University

Hamish Robertson, University of Washington
Guy Savard, Argonne National Laboratory
Bradley Sherrill, Michigan State University
Gene Sprouse, State University of New York at Stony Brook
Werner Tornow, Duke University
Robert Tribble, Texas A&M University
Michael Wiescher, Notre Dame University

RIA Workshop Working Groups and Conveners

Nuclear Structure: Cyrus Baktash, Paul Fallon, Thomas Glasmacher, Robert Janssens and Kim Lister

Astrophysics: Peter Parker and Michael Wiescher

Fundamental Interactions: Alejandro Garcia and Robert Tribble

Reactions: Bill Lynch and Lee Sobotka

Reality Check Group: Jim Beene, I-Yang Lee, David Morrissey, Jerry Nolen, Guy Savard and Paul Schmor